



Info prodotto 2022.1

20.11.2020

it's my window

FERRAMENTA STANDARD LINE ACCESSORI

ALsistem presenta la nuova linea ferramenta Standard Line, utilizzabile sui nostri sistemi a battente. Questi articoli che vi stiamo presentando si aggiungono agli accessori già presenti a catalogo.

Nelle pagine seguenti trovate l'elenco degli articoli, suddiviso per tipologia:

- Finestre (pag. 2-4);
- Anta a ribalta (pag. 5-6);
- Porte (pag. 7).

EasyDoor	
● Ecoslim 50 TT	
● Ecoslim 62 TT	
● Ecoslim 72 TT	
Elite Door 72	
Door 62	
Door 72	
Sirio 50	
● Smart 30	
● Planet 45	
● Planet 50 TT	
● Planet 50 PLUS	
● Planet 62 TT	
● Planet 62 PLUS	
● Planet 72 HT	
● Planet 72 PLUS	
● 3G	
● Fullglazing	
Matic 50	
Matic 50 PLUS	
Matic 62 TT	
Matic 62 PLUS	
Matic 72	
Matic 72 PLUS	
3G Matic	
Nathura 59	
Nathura 70	
Nathura 82	
Nathura 92	
Slide 60	
Slide 65	
Slide 80/106 PLUS	
Topslide 160 PLUS	
Slidewood 160	
Topslidewood 214	
Panoramico	
Balconi e balaustre	

FERRAMENTA STANDARD LINE FINESTRE

	<p>ACP 50405</p> <p>Cerniera finestra piastrini premontati per telai piani Cfz: 20 pz</p> <p><i>Pre-assembled plate window hinge for flat frames Pkg: 20 pcs</i></p>		<p>ACP 5165</p> <p>Braccio limitatore di apertura Cfz: 10 pz</p> <p><i>Opening limiting arm Pkg: 10 pcs</i></p>
	<p>ACP 50407</p> <p>Cerniera terza anta/telai complanari piastrini premontati Cfz: 20 pz</p> <p><i>Third leaf hinge / coplanar frames with pre-assembled plates Pkg: 20 pcs</i></p>		<p>ACP 5199</p> <p>Meccanismo martellina bidirezionale Cfz: 5 pz</p> <p><i>Handle bidirectional mechanism Pkg: 5 pcs</i></p>
	<p>ACP 50422</p> <p>Kit catenacci e terminali in nylon con puntale scaricato per alloggiamento (utile anche per a/r) Cfz: 50 kit</p> <p><i>Kit of bolts and nylon ends with unloaded tip for striker housing (also useful for return) Pkg: 50 kits</i></p>		<p>ACP 50226</p> <p>Piastrino sostegno anta Cfz: 500 pz</p> <p><i>Leaf support plate Pkg: 500 pcs</i></p>
	<p>ACP 50452</p> <p>Kit catenacci in zama anta abbinata per battente standard (con terminale registrabile e 2 incontri). Cfz: 10 kit</p> <p><i>Zamak bolt kit for matching leaf for standard leaf (with adjustable end piece and 2 strikers) Pkg: 10 kits</i></p>		<p>ACP 5012</p> <p>Cerniera vasistas scatto singolo Cfz: 10 pz</p> <p><i>Hinge, single snap for bottom hung open in Pkg: 10 pcs</i></p>
	<p>ACP 51454</p> <p>Rostro per ferramenta standard Cfz: 50 pz</p> <p><i>Rostrum for standard hardware Pkg: 50 pcs</i></p>		<p>ACP 5017</p> <p>Cricchetto vasistas applicazione rapida Cfz: 50 pz</p> <p><i>Awning/hopper window quick fitting finger catch Pkg: 50 pcs</i></p>

FERRAMENTA STANDARD LINE FINESTRE

	<p>ACP 50410</p> <p>Kit punto di chiusura a fungo di sicurezza Cfz: 20 kit</p> <p><i>Safety closure point kit Pkg: 20 kits</i></p>		<p>ACP 50433</p> <p>Cremonese bidirezionale Aurora senza manico Cfz: 10 pz</p> <p><i>Aurora bidirectional cremone bolt without handle Pkg: 10 pcs</i></p>
	<p>ACP 50400</p> <p>Cremonese bidirezionale aurora Cfz: 10 pz</p> <p><i>Aurora bidirectional cremone bolt Pkg: 10 pcs</i></p>		<p>ACP 50434</p> <p>Cremonese a/r Aurora senza manico Cfz: 10 pz</p> <p><i>Aurora a / r cremone bolt without handle Pkg: 10 pcs</i></p>
	<p>ACP 50411</p> <p>Bracci a sporgere telescopici Cfz: 10 cp</p> <p><i>Extendable telescopic arms Pkg: 10 cp</i></p>		<p>ACP 50445</p> <p>Blocchetti collegamento cremonese Cfz: 100 cp</p> <p><i>Cremone connection blocks Pkg: 100 cp</i></p>
	<p>ACP 50421</p> <p>Kit punto di chiusura registrabile Cfz: 10 kit</p> <p><i>Adjustable locking point kit Pkg: 10 kits</i></p>		<p>ACP 50458</p> <p>Kit 6 punti di chiusura Cfz: 10 kit</p> <p><i>6 locking points kit Pkg: 10 kits</i></p>
	<p>ACP 50432</p> <p>Impugnatura asportabile cremonese Aurora. Cfz: 10 pz</p> <p><i>Removable aurora handle Pkg: 10 pcs</i></p>		<p>ACP 50475</p> <p>Kit finestra 1 anta battente Cfz: 10 kit</p> <p><i>Window kit 1 hinged door Pkg: 10 kits</i></p>



Info prodotto 2022.1

20.11.2020





it's my window

FERRAMENTA STANDARD LINE FINESTRE

	<p>ACP 50525</p> <p>Terminale asta Cfz: 50 pz</p> <p><i>Rod terminal Pkg: 50 pcs</i></p>
	<p>ACP 50582</p> <p>Incontro doppio in nylon Cfz: 100 pz</p> <p><i>Double nylon striker Pkg: 100 pcs</i></p>

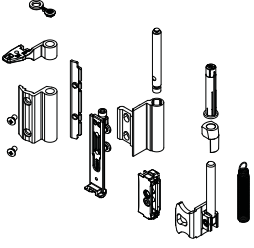
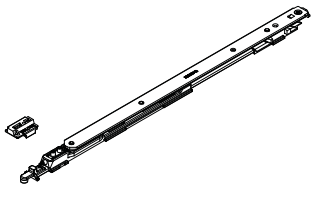
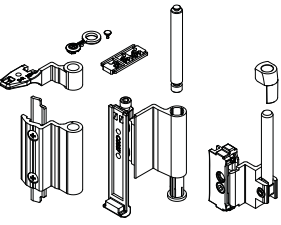
FERRAMENTA STANDARD LINE

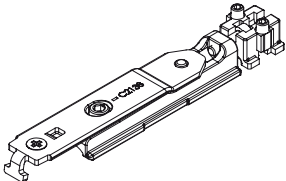
ANTA A RIBALTA

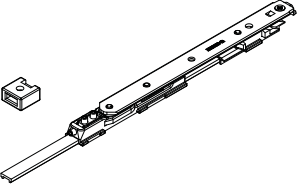
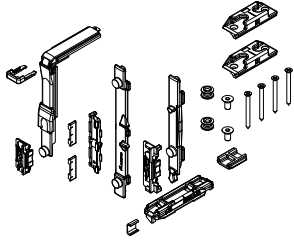
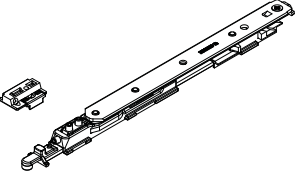
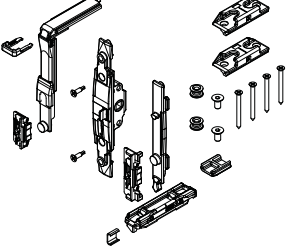
	<p>ACP 50456</p> <p>Cerniere a/r telai piani Cfz: 10 pz</p> <p><i>Round hinges for flat frames Pkg: 10 pcs</i></p>		<p>ACP 50446/538</p> <p>Braccio ribalta lungo per ante da 701 a 1800mm con microventilazione Cfz: 10 pz</p> <p><i>Long tilt arm for doors from 701 to 1800mm with microventilation Pkg: 10 pcs</i></p>
	<p>ACP 50457</p> <p>Cerniere a/r telai complanari Cfz: 10 pz</p> <p><i>A / r hinges on coplanar frames Pkg: 10 pcs</i></p>		<p>ACP 50447</p> <p>Kit catenacci per a/r standard (con prolunga alluminio) Cfz: 10 kit</p> <p><i>Deadbolt kit for standard round trip (with aluminum extension) Pkg: 10 kits</i></p>
	<p>ACP 50459</p> <p>Adattatore anta abbinata per cerniere ACP 50456 e ACP 50457 Cfz: 10 pz</p> <p><i>Matching door adapter for ACP 50456 and ACP 50457 hinges Pkg: 10 pcs</i></p>		<p>ACP 50448</p> <p>Traino per cremonese monodirezionale Cfz: 10 pz</p> <p><i>Towing for monodirectional cremone bolt Pkg: 10 pcs</i></p>
	<p>ACP 50446/350</p> <p>Braccio ribalta extra corto per ante da 350 a 410mm Cfz: 10 pz</p> <p><i>Extra short tilt arm for doors from 350 to 410mm Pkg: 10 pcs</i></p>		<p>ACP 50476</p> <p>Kit a/r con traino per cremonese e 2 funghetti AE Cfz: 10 kit</p> <p><i>A / r kit with drive for cremone bolt and 2 anti-burglary locking point Pkg: 10 kits</i></p>
	<p>ACP 50446/415</p> <p>Braccio ribalta corto per ante da 410 a 700mm con microventilazione Cfz: 10 pz</p> <p><i>Short tilt arm for doors from 410 to 700mm with microventilation Pkg: 10 pcs</i></p>		<p>ACP 50477</p> <p>Kit a/r con meccanismo martellina e 2 funghetti AE Cfz: 10 kit</p> <p><i>A / r kit with handle mechanism and 2 anti-burglary locking point Pkg: 10 kits</i></p>

FERRAMENTA STANDARD LINE ANTA A RIBALTA

	<p>ACP 50478</p> <p>Kit a/r con meccanismo EXENS e 2 funghetti AE Cfz: 10 kit</p> <p><i>A / r kit with EXENS mechanism and 2 anti-burglary locking point Pkg: 10 kits</i></p>		<p>ACP 50401</p> <p>Cremonese a/r Aurora Cfz: 10 pz</p> <p><i>Cremonese a / r aurora Pkg: 10 pcs</i></p>
	<p>ACP 50546/415</p> <p>Braccio ribalta corto per ante da 410 a 700mm manovra logica Cfz: 10 pz</p> <p><i>Short tilting arm for doors from 410 to 700mm logic operation Pkg: 10 pcs</i></p>		<p>ACP 50482</p> <p>Incontro doppio in nylon Cfz: 100 pz</p> <p><i>Double nylon striker Pkg: 100 pcs</i></p>
	<p>ACP 50546/538</p> <p>Braccio ribalta lungo per ante da 550 a 1800mm manovra logica Cfz: 10 pz</p> <p><i>Long tilting arm for doors from 550 to 1800mm logic operation Pkg: 10 pcs</i></p>		<p>ACP 5153</p> <p>Braccio supplementare da abbinare ad ACP 5151, ACP 5163 e ACP 50446/538 per ante superiori a 1000mm Cfz: 5 kit</p> <p><i>Additional window arm for ACP 5151, 5163, 50446/550 for L>1000mm window Pkg: 5kit</i></p>
	<p>ACP 50323</p> <p>Kit a/r con meccanismo EXENS per manovra logica Cfz: 10 kit</p> <p><i>A / r kit with EXENS mechanism for logic operation Pkg: 10 kits</i></p>		
	<p>ACP 50481</p> <p>Kit a/r con traino cremonese per manovra logica Cfz: 10 kit</p> <p><i>A / r kit with cremone bolt drive for logical maneuver Pkg: 10 kits</i></p>		



Info prodotto 2022.1

20.11.2020

it's my window

FERRAMENTA STANDARD LINE PORTE



ACP 9918N

Cerniera STRONG EVO 2 ali
per telai piani
Cfz: 20 pz

*STRONG EVO 2-wing hinge for flat frames
Pkg: 20 pcs*



ACP 9938N

Cerniera STRONG EVO 2 ali per
terza anta e telai coplanari
Cfz: 20 pz

*STRONG EVO 2-wing hinge for third sash and
coplanar frames
Pkg: 20 pcs*



ACP 50341

Basetta copricilindro
Cfz: 20 pz

*Cylinder cover base
Pkg: 20 pcs*